

Application of Multi-Antenna GPS Technology in Monitoring Stability of Slopes

**X.L. Ding, W.J. Dai, W.T. Yang, X.W. Zhou, J. Lam, HONG KONG, CHINA
Q. Zhang, L. Wang, CHINA**

Key words: Multi-antenna GPS, slope monitoring, landslides.

SUMMARY

There are a great number of man-made and natural slopes in many parts of the world including Hong Kong and Mainland China. For example, there are over 40,000 slopes in Hong Kong registered by the Hong Kong Government. Landslides due to slope failures can often cause catastrophes that involve the loss of both lives and important facilities. GPS has been demonstrated to have great potentials for use in monitoring slope stability and landslides. However, the high hardware cost of GPS has limited the wide spread use of GPS for such applications. The multi-antenna GPS technology initiated by the research group and our collaborators has significantly reduced the cost of GPS and provided a solution to a number of associated problems such as data management and power supply. This paper discusses practical applications of multi-antenna GPS technology in slope monitoring, including system design, setting up, data transmission and management, and data quality analysis and control. Some slope monitoring examples are given to illustrate the points discussed.

Application of Multi-Antenna GPS Technology in Monitoring Stability of Slopes

X.L. Ding, W.J. Dai, W.T. Yang, X.W. Zhou, J. Lam, HONG KONG, CHINA
Q. Zhang, L. Wang, CHINA

1. INTRODUCTION

There are a great number of man-made and natural slopes in many parts of the world including Hong Kong and Mainland China. For example, there are over 40,000 slopes in Hong Kong registered by the Hong Kong Government. Landslides due to slope failures can often cause catastrophes that involve the loss of both lives and important facilities. GPS has been demonstrated to have great potentials for monitoring slope stability and landslides. Episodic measurement and continuous monitoring approaches have been both used in practice. In episodic measurement mode, monitoring points are surveyed regularly, say once a few days to a few months depending on the stability of the slopes. Continuous monitoring is important for slopes that may fail under certain conditions and their failures impose threat to lives or important facilities. Continuous GPS monitoring systems can provide real-time or near real-time information on the stability of a slope. Besides, such systems can also reduce the manpower required to take field observations as well as systematic errors such as the GPS antenna setting-up errors. However, the high hardware cost of GPS is a limiting factor for the wide spread use of GPS for slope monitoring applications. The multi-antenna GPS technology developed by the research group and our collaborators is able to significantly reduce the cost of GPS monitoring systems. In addition, the technology also makes it much easier to manage the data flow in the monitoring process and to provide power supply needed on the site (Ding et al., 2000; 2003; Yin et al., 2003; He et al., 2005).

We will from a practical point of view look into how the multi-antenna GPS technology can be applied to slope monitoring. Results from some application examples will also be presented.

2. SYSTEM STRUCTURE

The multi-antenna GPS system consists of data receiving equipment, data links and data processing, analysis and management software. The structure of a complete system is illustrated in Figure 1.

2.1 Hardware

The main hardware components of the system are:

GPS multi-antenna control unit. This electronic component has multiple input and single output channels. It is connected between the antennas and the receiver and allows GPS signals from each of the antennas to be logged sequentially into the receiver. With the help of the

multi-antenna control unit, one GPS receiver works effectively as a number of receivers. The time interval for the receiver to be connected to each of the antennas can be specified by the user to suit different application requirements.

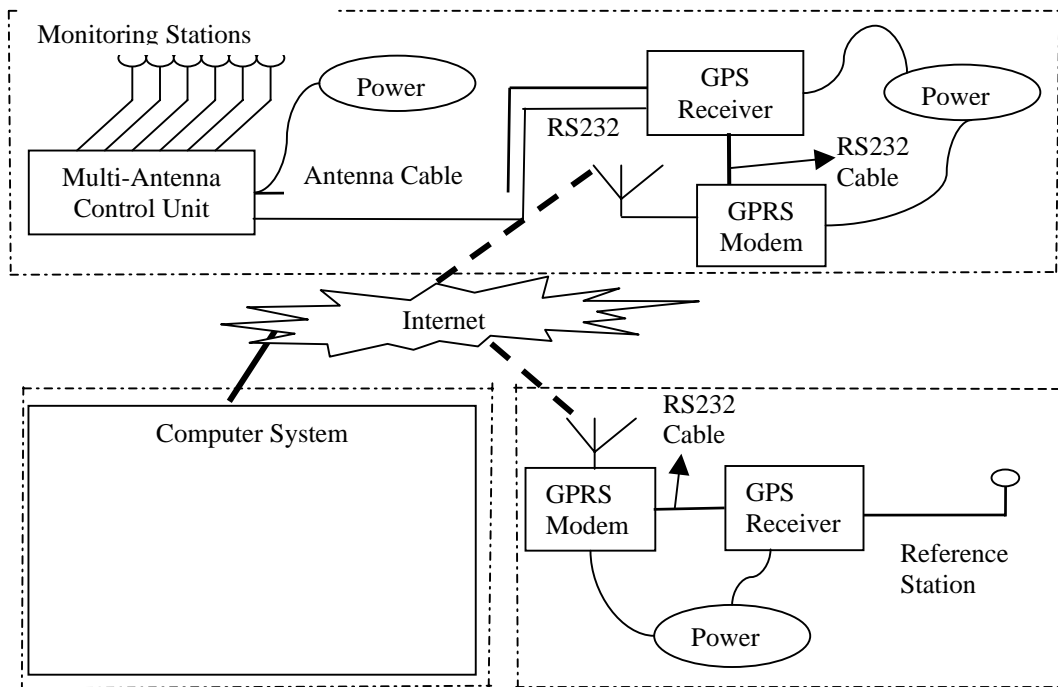

Fig 1. Multi-antenna GPS system structure



Fig 2. GPS multi-antenna control unit

GPS receivers, antennas and signal amplifiers. Any standard GPS receivers and antennas can be used with this system. The maximum number of the antennas depends on the design of the multi-antenna control unit. The current design of the system uses eight antennas. The antennas are connected to the receiver on site through the antenna control unit. Good quality antenna cables can allow up to 120 m distance between the receiver and an antenna. For longer distances, in-line signal amplifiers can be used to compensate the loss of signal

strength through a cable. The length of an antenna cable can be up to about 300 m if a signal amplifier is used.

Data links. Data links are used to transmit data acquired on a monitored site to a data processing and analysis center, basically a personal computer located in an office. Since standard off-the-shelf GPS receivers are used, a number of options are available for data communications, including, e.g., radio, internet, GSM, GPRS and CDMA.

2.2 Software

The multi-antenna GPS system has three software components for antenna switching control, data logging and data processing respectively:

Antenna Switching Control Software. This is a program installed in the antenna control unit. Its main functions include setting the switching time interval and connecting to the antennas.

Data Logging Software. The software controls data logging parameters and output GPS observations.

Data Processing Software. This is a GUI application software running in Windows XP system (Figure 3). The software allows the user to process, analyze and manage GPS data. Data processing can be done either with the assistance of the user or in fully automatic mode. For automatic monitoring purpose, it runs with a data logging software together. The software also allows the user to manage projects, and visualize and manage results.

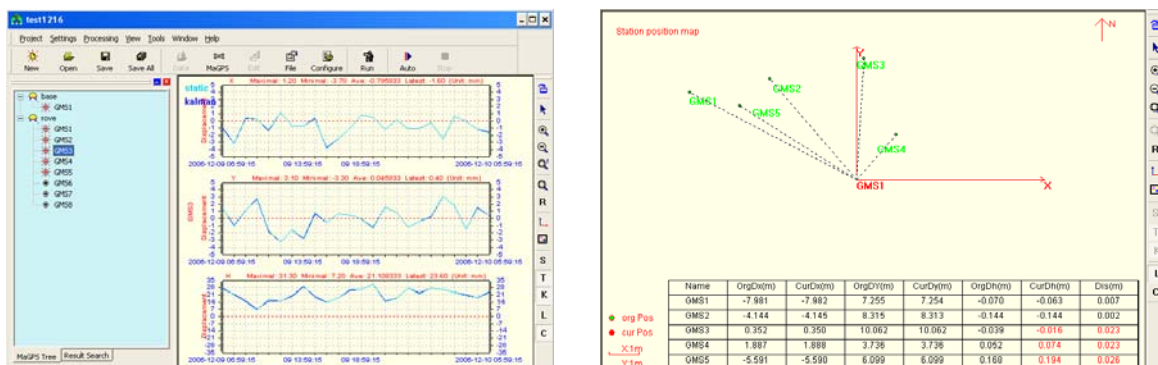

Fig 3. Main data processing software interface

3. SYSTEM SET UP

The following is the basic procedure for setting up the multi-antenna GPS system;

- (1) Installation of GPS receivers, antennas, antenna control unit, power supply system, and communication links.

- (2) Determination of the original positions of the monitoring points.

To determine the accurate initial positions of the monitored points, static GPS surveys with say over 30 minutes of data for each antenna should be carried.

- (3) Creation of project and configuration of parameters in the data processing software.
- (4) Configuration of the GPS receivers and starting up data logging.
- (5) Starting up data processing and normal system operatoin.

4. APPLICATION EXAMPLES

4.1 Accuracy Test

A series of tests were carried out on the roof top of a building at The Hong Kong Polytechnic University. There were 5 concrete pillars on the roof (Figure 5). A device that can move the antenna in three dimensions was used to simulate various antenna movements (Figure 6). Figure 7 shows the displacement of Point 5 from 12:00 on Jan 11 to 12:00 on Jan 15. The raw observation data sampling interval was 5 seconds. The solution was updated every one hour. From 13:00 to 17:00 on Jan 11, the position of point 5 was moved 1cm every hour in the X and H directions. From 13:00 to 17: on Jan 12, the antenna was moved back 1cm every hour. From 13: 00 to 15:00 it was moved 1 cm every 1 hour again. The results show that the measured displacements are very close to those moved.



Fig 5. Deformation monitoring test site



Fig 6. Antenna movement device

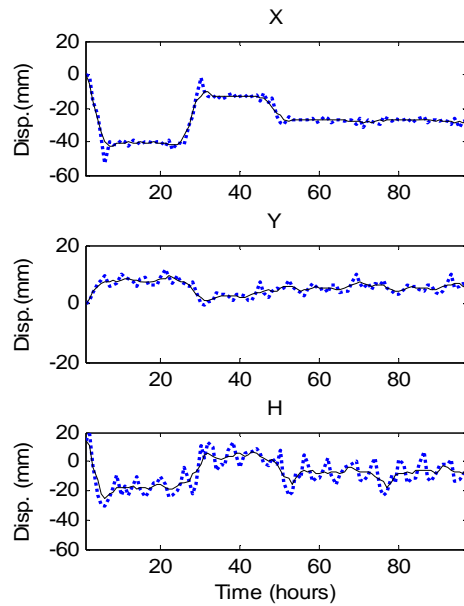

Fig7. The measured displacement series

4.2 Landslide over a Reservoir

On May 12, 2006, a multi-antenna GPS system was installed on a slope near the Heihe Reservoir in Xi'an, China. A highway passes through the middle of the slope so that the slope was separated into two parts (See Figure 8). The stability of the slope is a great concern. Four concrete pillars were set up on the lower part of the slope and two were set up on the higher part. Since the antenna cable could not go through the highway, only 4 pillars (Nzs3, Nzs4, Nzs5, Nzs6) were equipped with GPS antennas. The reference station (Nzs1) was set up near the slope site (about 500 m away from the site). Ashtech GPS receivers and antennas were used in the test. The data sampling interval was 5 seconds. The system logged data from each antenna for 30 seconds before it switched to the next antenna. The test was divided into three sessions, each being about 3 hours (from 9:00 to 19:00).

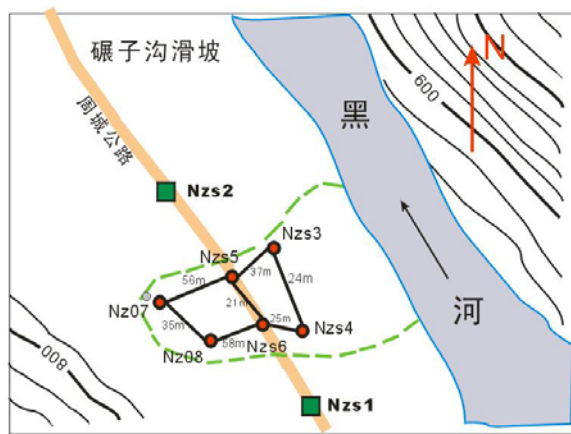

Fig 8. The monitored landslide over a reservoir

The results from the test are shown in Table 1. Both the horizontal and vertical coordinates had a repeatability of better than 5 mm.

Table 1. Results from a landslide monitoring test over a reservoir

		X (m)	Dx (mm)	Y (m)	Dy (mm)	H (m)	Dh (mm)
NZS3	Average	166.7577		-149.9155		-23.2901	
	Session1	166.7558	-1.9	-149.9174	-1.9	-23.2893	0.8
	Session2	166.7612	3.5	-149.9150	0.5	-23.2893	0.8
	Session3	166.7560	-1.7	-149.9142	1.3	-23.2917	-1.6
NZS4	Average	146.1073		-139.6450		-16.3335	
	Session1	146.1067	-0.6	-139.6483	-3.3	-16.3342	-0.7
	Session2	146.1098	2.5	-139.6458	-0.8	-16.3354	-1.9
	Session3	146.1055	-1.8	-139.6410	4.0	-16.3310	2.5
NZS5	Average	151.3088		-173.7429		-0.3603	
	Session1	151.3092	0.4	-173.7439	-1.0	-0.3627	-2.4
	Session2	151.3088	0.0	-173.7423	0.6	-0.3573	3.0
	Session3	151.3083	-0.5	-173.7424	0.5	-0.3610	-0.7
NZS6	Average	139.9031		-156.8506		-0.4226	
	Session1	139.9021	-1.0	-156.8511	-0.5	-0.4252	-2.6
	Session2	139.9034	0.3	-156.8507	-0.1	-0.4176	5.0
	Session3	139.9039	0.8	-156.8501	0.5	-0.4250	-2.4

4.3 Monitoring of a Roadside Slope

A multi-antenna GPS system was set up on a roadside slope on September 15th, 2006 (Figure 5). The system has been in operation since then. Eight antennas were installed on the slope and connected to the system. A reference receiver/antenna was set up on the concrete pillar. The data sampling interval is 5 seconds and the data recording time for each antenna in each round is 1 minute. Figures 6 to 8 show the point displacement series in the three directions with 30 minutes, 1 hour and three hours of result update interval. Tables 2 to 4 give the RMS values of the data series.

It can be seen from the results that unstandably longer measurement time produces higher accuracy results. The accuracies of GMS4 and GMS4 are lower than those of the orther points. The reason for this is considered due to the locations of the two points are at the bottom of the slope so that more satellites are masked for the two points. Among the three coordinate components, the accuracy of the Y coordinates (East direction) is the highest, the accuracy of the X coordinates (North direction) is slightly lower than that of the Y coordinates while the accuracy of the H coordinates (up direction) is the lowest. The slope itself blocked some of the satellites in the south so that reduced the accuracy of the X coordinates to certain extent.

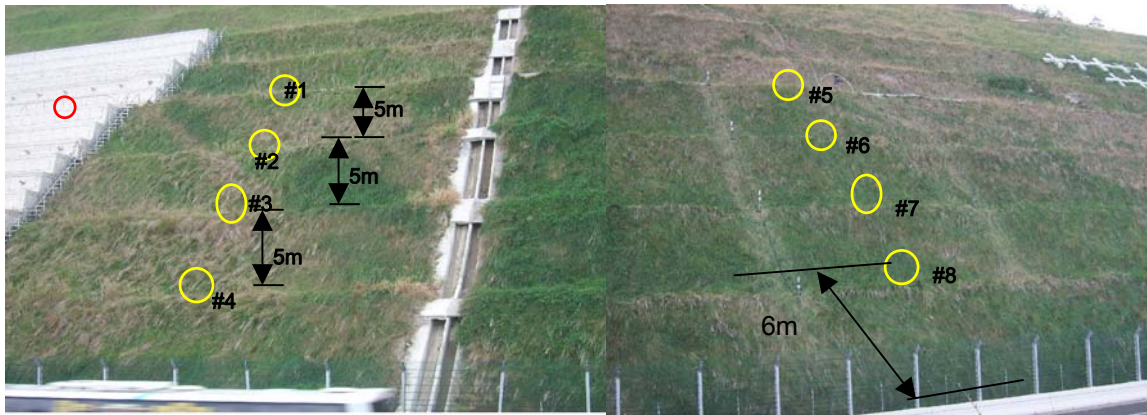

Fig 9. The roadside slope and the points monitored

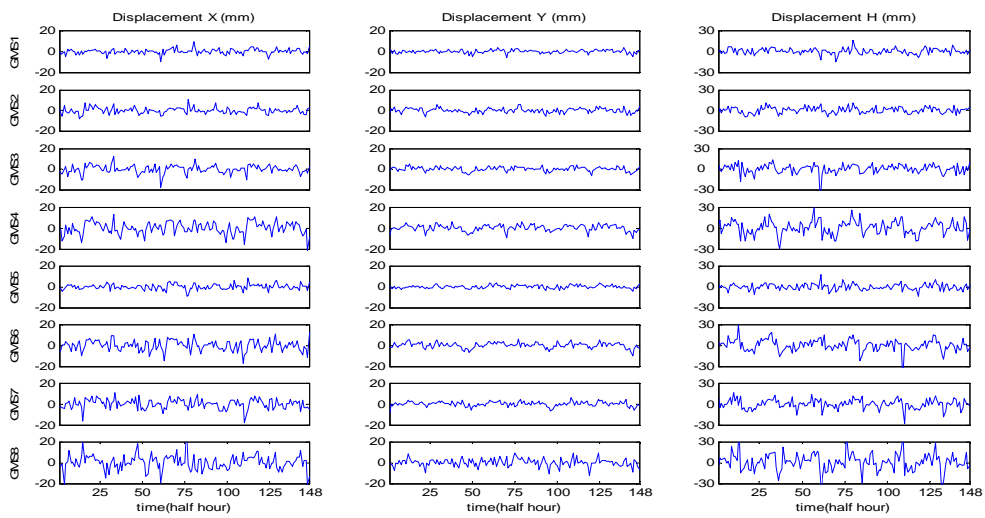

Fig 10. Displacement series in with 30 minute data update interval

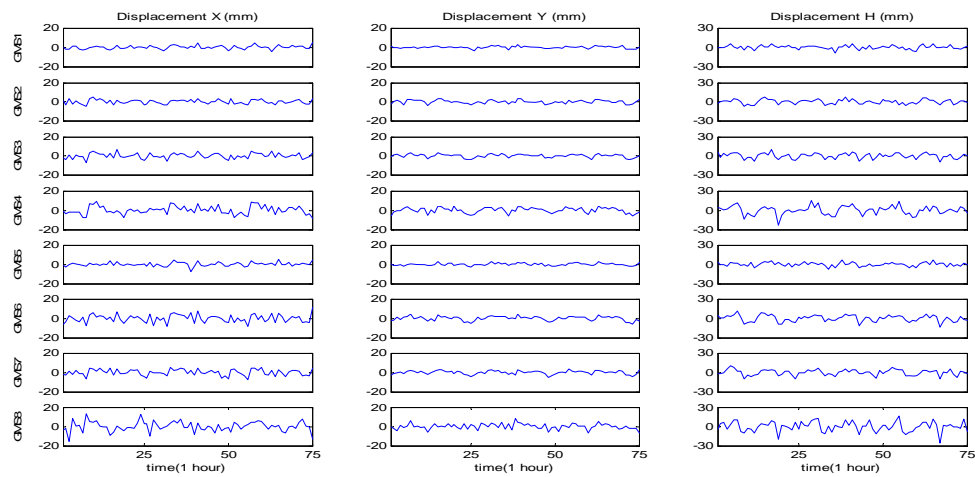

Fig 11. Displacement series with 1 hour data update interval

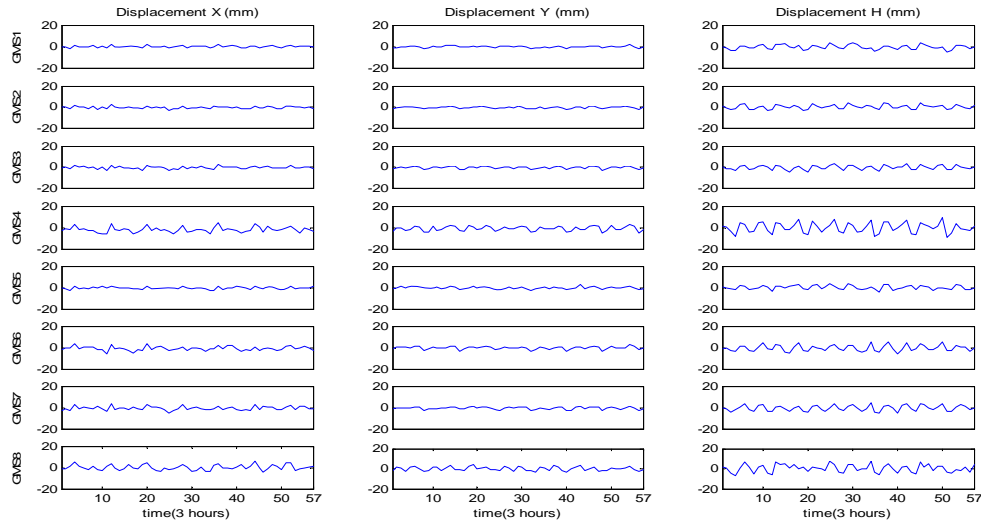

Fig 12. Displacement series with 3 hour data update interval

Table2. RMS values of the coordinate series (interval=30min) (unit: mm)

RMS value	GMS1	GMS2	GMS3	GMS4	GMS5	GMS6	GMS7	GMS8	Average
X	2.5	3.0	4.0	5.9	2.7	5.1	4.6	7.4	4.4
Y	1.7	2.2	2.2	3.0	1.6	2.7	2.3	3.7	2.4
H	4.2	4.5	6.8	9.8	4.4	8.1	6.7	12.5	7.1

Table3. RMS value of the coordinate series (interval=1hour) (unit: mm)

RMS value	GMS1	GMS2	GMS3	GMS4	GMS5	GMS6	GMS7	GMS8	Average
X	1.8	2.2	2.8	4.2	2.0	4.0	3.3	5.1	3.2
Y	1.2	1.7	1.7	2.7	1.3	2.2	1.8	2.9	1.9
H	2.8	3.4	4.1	6.6	2.8	5.0	4.5	7.7	4.6

Table4. RMS value of the coordinate series (interval=3hour) (unit: mm)

RMS value	GMS1	GMS2	GMS3	GMS4	GMS5	GMS6	GMS7	GMS8	Average
X	0.9	1.2	1.3	3.2	1.2	2.1	1.9	2.4	1.8
Y	0.9	1.0	1.2	2.3	1.1	1.4	1.2	1.9	1.4
H	2.1	2.0	2.1	4.7	1.9	2.9	2.7	3.8	2.8

5. CONCLUSIONS

The multi-antenna GPS technology has significantly lowered the cost of GPS hardware for applications such as slow stability monitoring, in addition to other advantages that it brings, including the ease in managing the data flow and providing power supplies to the system. The system can be fully automated in operation so that it can reduce the cost of personnel as well as allow more data to be taken. We have looked into how the technology can be applied to monitoring landslides in practice. The application examples have shown that the system can provide accurate and reliable measurement results. About 2mm measurement accuracy can be achieved in the three coordinate components under typical slope site conditions.

ACKNOWLEDGMENTS

The research was supported by the Research Grants Council of the Hong Kong Special Administrative Region (Project No.: PolyU 5148/04E).

REFERENCES

- Ding X., Chen Y., Huang D., Zhu J., Tsakiri M., and Stewart (2000). Slope Monitoring using GPS- A Multi-antenna Approach. *GPSWorld*, 11(3):52-54.
- Ding, X.L., Huang, D.F., Yin, J.H., Chen, Y.Q., Lau, C.K., Yang, Y.W., Sun, Y.R., Chen, W., He, X.F. (2003) Development and Field Testing of a Multi-Antenna GPS System for Deformation Monitoring, *Wuhan University Journal of Natural Sciences*, Vol. 8, No. 2B, pp. 671-676.
- He, X.F., Sang, W.G., Chen, Y.Q., Ding, X.L. (2005) Steep-slope monitoring: GPS multiple-antenna system at Xiaowan dam, *GPS World*, November, pp. 20-25.
- Yin, J.H., Ding, X.L., Yang, Y.W., Lau, C.K., Huang, D.F. and Chen, Y.Q. (2003) Integration of Conventional Instruments and GPS for Remote Automatic Monitoring of Slopes, *Chinese Journal of Rock Mechanics and Engineering*, 23(3):357-364. (in Chinese).

BIOGRAPHICAL NOTES

Xiaoli Ding is a Professor in the Department of Land Surveying and Geo-Informatics, The Hong Kong Polytechnic University, Hong Kong. His research interests include GNSS, InSAR and geodynamics. He received his Ph.D. from the University of Sydney, Australia in 1993.

Wujiao Dai is a Research Assistant in the Department of Land Surveying and Geo-Informatics, The Hong Kong Polytechnic University, Hong Kong. His research focuses on developing GNSS algorithms and software for structural deformation monitoring.

CONTACTS

Professor Xiaoli Ding
Department of Land Surveying and Geo-Informatics, The Hong Kong Polytechnic University,
Hung Hom, KLN, Hong Kong
CHINA
Tel. + 852- 9227 8168
Fax + 852- 2330 2994
Email: lsxlding@polyu.edu.hk
Web site: <http://www.lsgi.polyu.edu.hk/>