

SURVEYING THE SHAPER

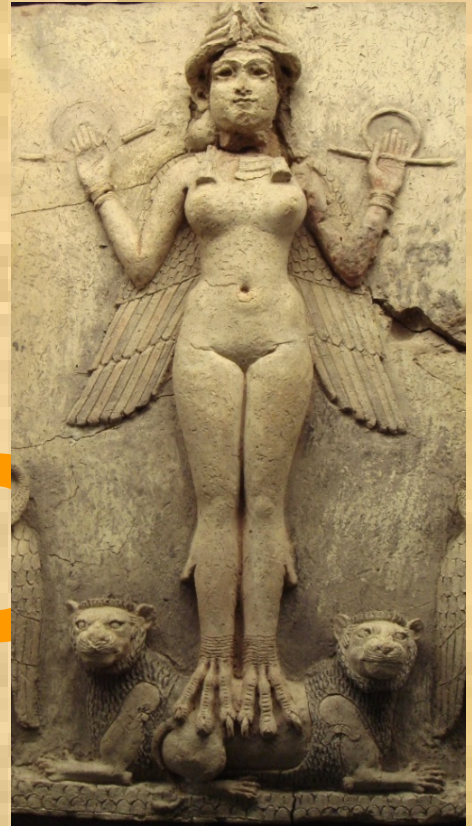

=



WORLD

HISTORY



**GODDESS WITH
MEASURING
CORDS IN EACH
HAND**

**SHAMASH HANDS THE
MEASURING CORD AND
ROD TO THE KING ON
THE UR NAMMU STELA**



MESOPOTAMIAN KUDURRUS – BOUNDARY STONES c. 1100 BC



IN ADDITION TO THE OWNER OF THE LAND THE KING'S NAME IS USUALLY GIVEN PLUS THE NAME OF THE SURVEYOR/S OF THE PARCEL SUCH AS ENLIL-ZER-KINI & SHAPIKU



2. THE COUNCILOR AND OVERSEER OF BOUNDARIES, MITRY, AND HIS WIFE
From Saqqārah. About 2700 B.C. Wood. H. 52 and 58 in.

I gave bread to the hungry, I clothed the naked, I never robbed any man of his property so that he complained of me because of it to the god of my city. I speak no lie: I was one beloved of his father, praised of his mother, excellent in character to his brother, amiable to his sister.

Autobiography of a contemporary official.

WOODEN STATUE OF MITRY – THE COUNCILOR AND OVERSEER OF BOUNDARIES AND HIS WIFE (2700 BC)

AMENHOTEP SI SE

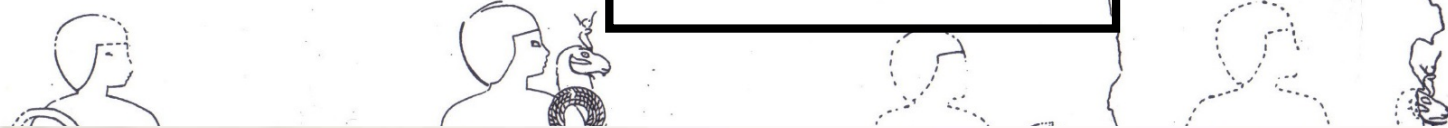

KHAEMHAT



DJERSERKARESENEB



MENNA

**GODDESS OF
THE SCRIBE
SURVEYORS:
SESHAT**



THE GOD OF
THE SCRIBE
SURVEYORS:

THOTH

(from a
sunken relief
in the Tomb of
Rameses II
At Abydos)



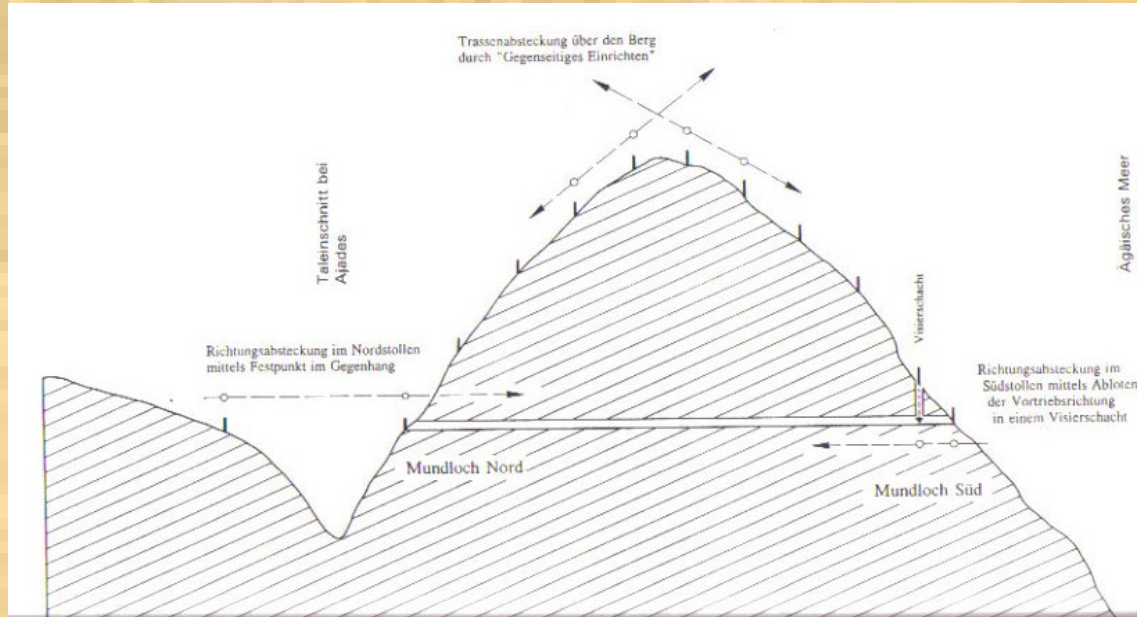
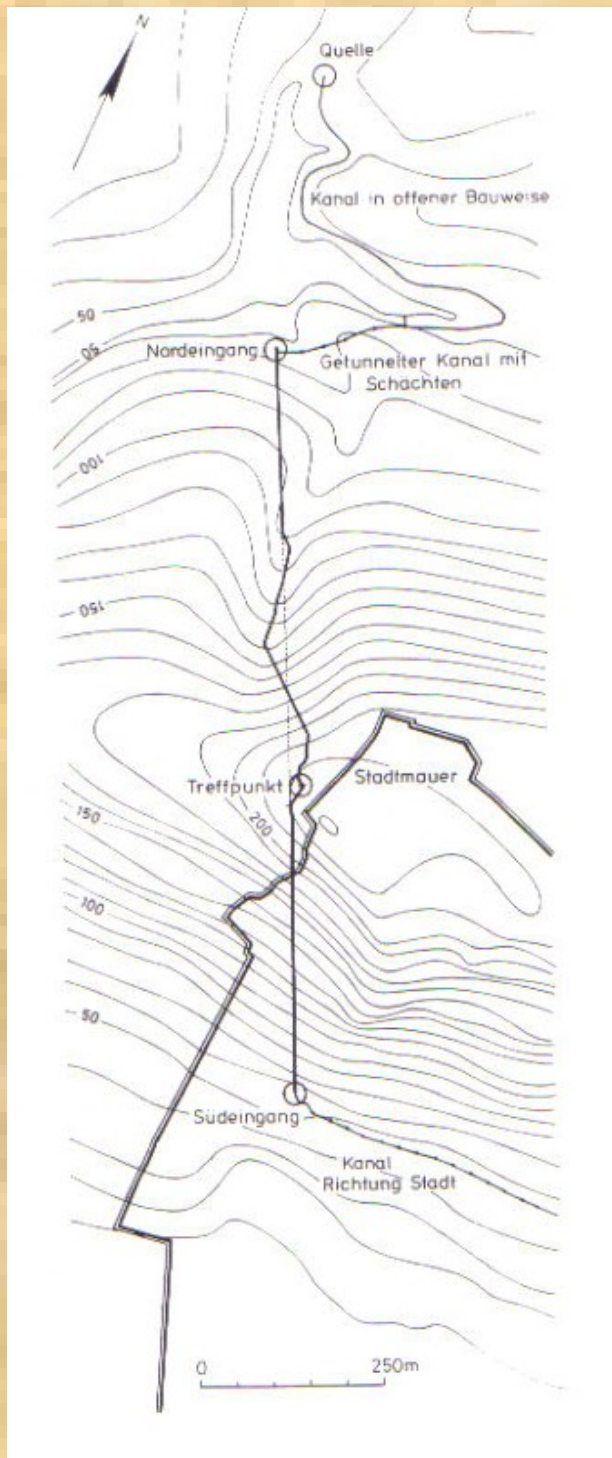

The Tunnel of Euphalinos on the Island of Samos (540 B.C.)

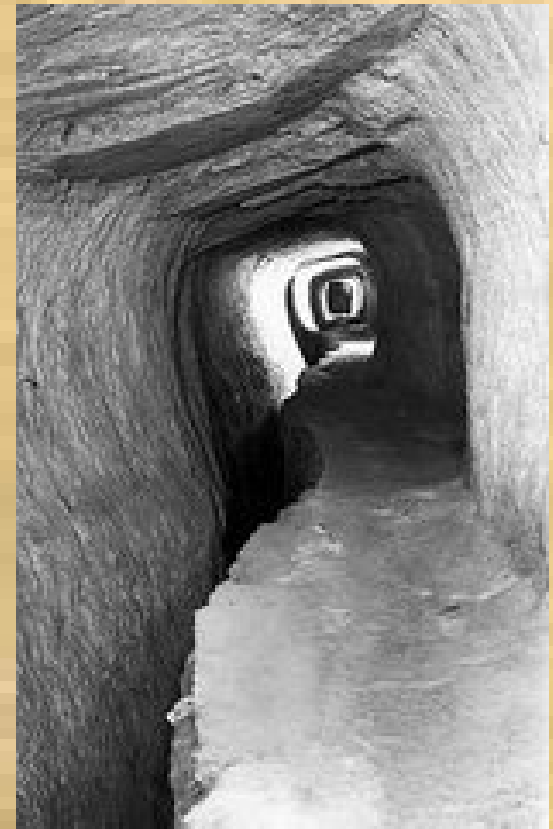

TERMINU
S:
ROMAN GOD
OF
BOUNDARY
STONES AS



THE WORKSHOP OF VERUS THE SURVEYOR IN VIA DELL'ABBONDANZA AT POMPEII 79 AD

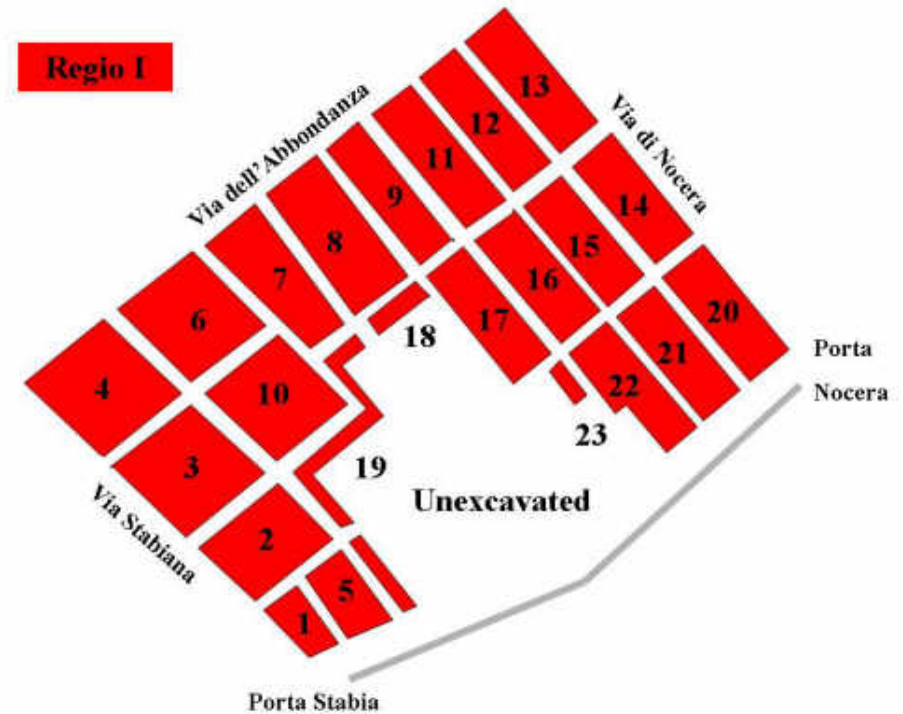

Regio I Insula 6

WORKSHOP OF
VERUS THE
GROMATICO

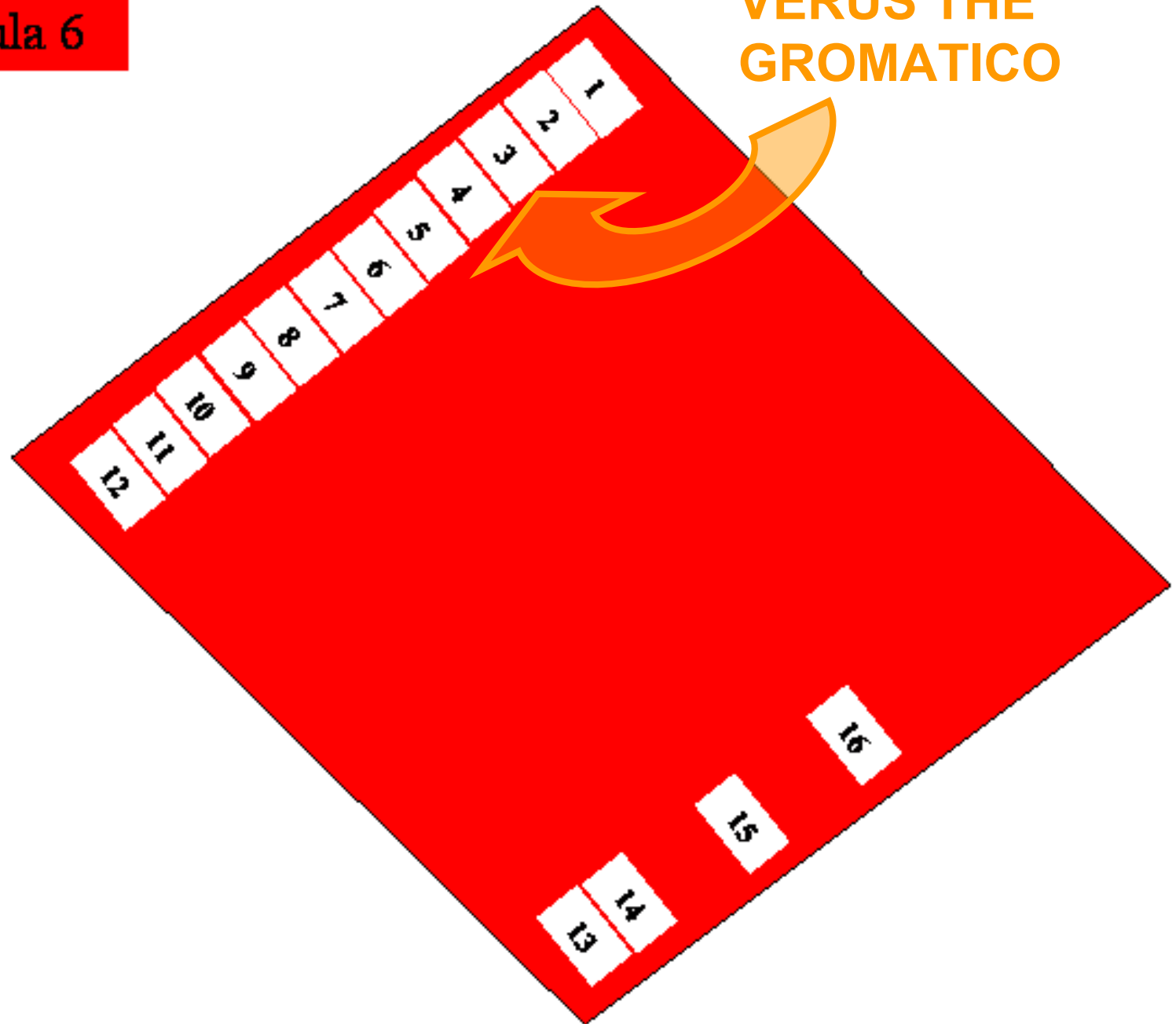

POMPEII WORKSHOP OF VERUS THE SURVEYOR





**RECREATION OF STREET FAÇADE OF VIA DELL'
ABBONDANZA**

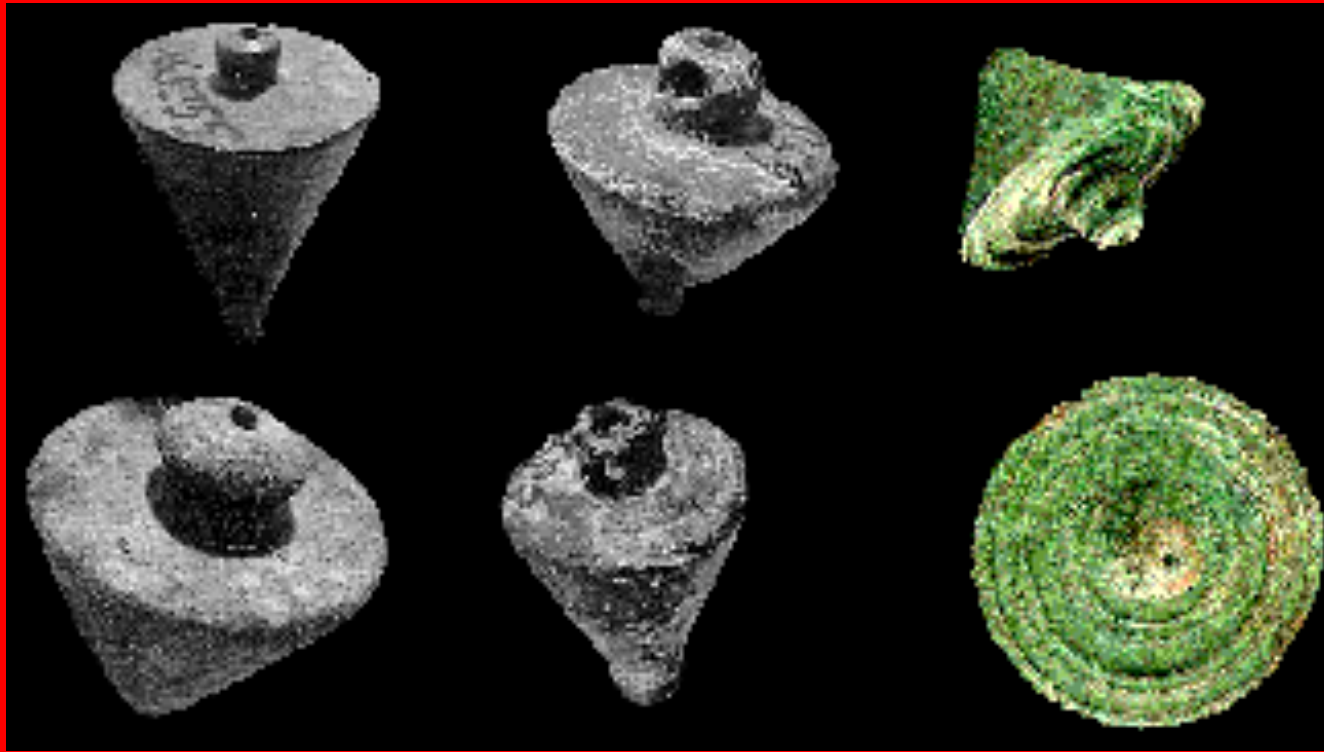

**PLUMB BOBS AND
A METAL GROMA TIP
FROM POMPEII**



L. oggetto nr. 76699
MUSEO ARCHEOLOGICO DELLA CITTA' DI ROMA
Data: 21/11/2011
II. Comune di Roma
per il deposito presso il Museo Archeologico della Città di Roma

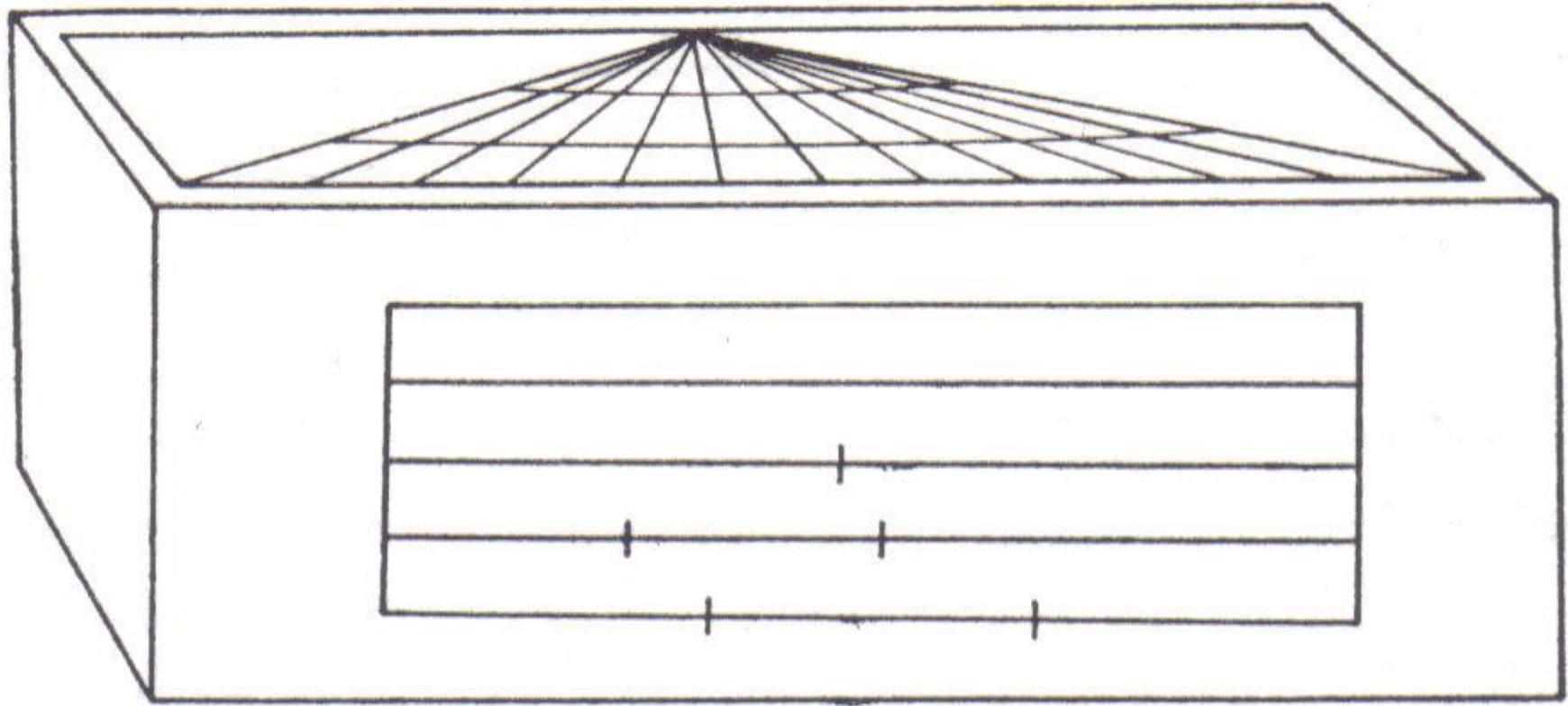

16. Ivory box from Pompeii, $10.6 \times 5.2 \times 3.8$ cm, serving as portable sundial and measure

**PORTABLE SUNDIAL
FOUND IN POMPEII**

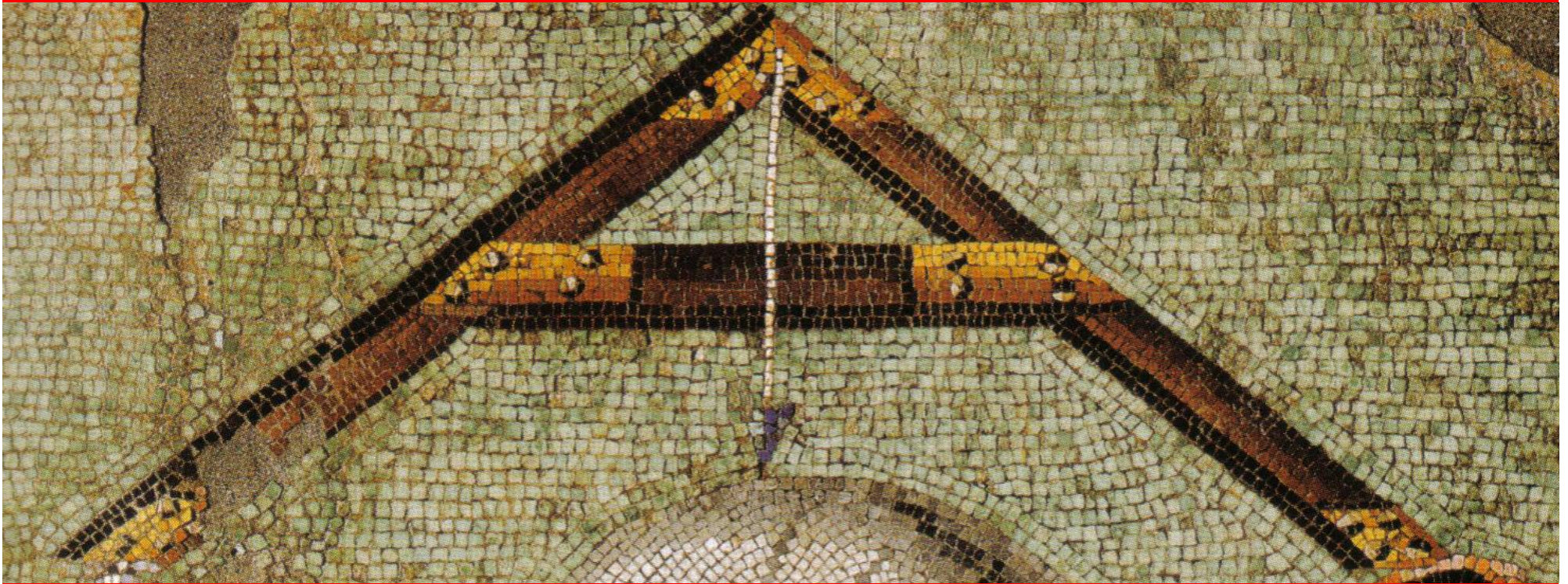

**ROMAN SURVEYING
INSTRUMENT
THE LIBELLA
WITH PLUMB BOB**



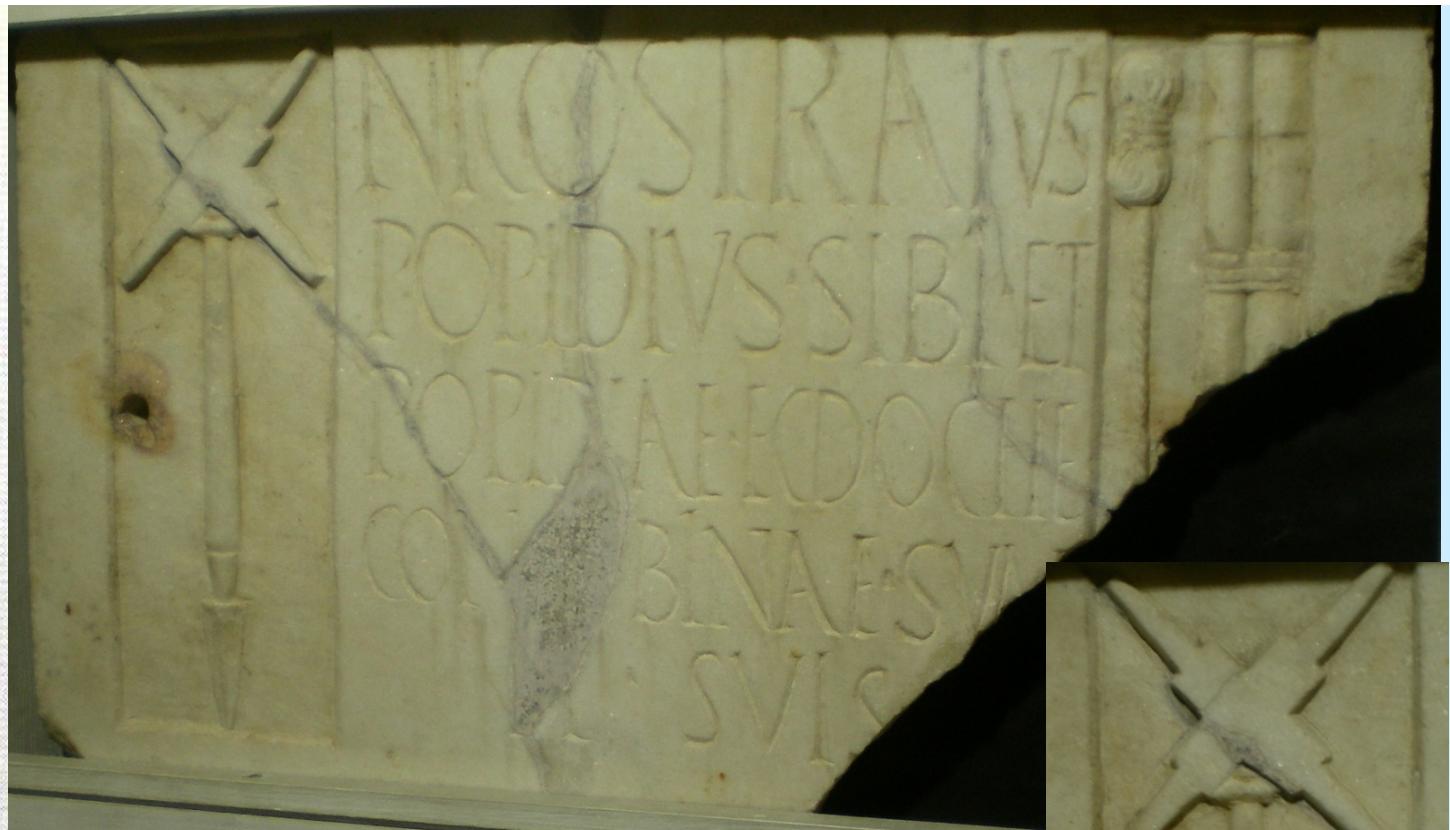

**THE GROMA ON THE
HEADSTONES OF
TWO SURVEYORS:
CLAUDIUS AEBUTIUS
FAUSTUS, IVREA &
NICOSTRATUS
POPIDIUS, POMPEII**





**THE
HEREFORD
MAPPAMUNDI
(1290-1300)**



Ite in orbem terrarum et de omnibus civitatibus et de rebus ad sanctam et ad istam confirmacionem hinc scriptis sigillum meum apposui

S

Sicut hi ceteri morie ont. Du o'ront ou l'iront ou ueront. Nient a ihesu en de'ce. De Richard de la d'ingham ont Laffod e're pite. hi lat fet e compasse. hi roie en cel li ser done.

Theodorum Theodocum polidatus.

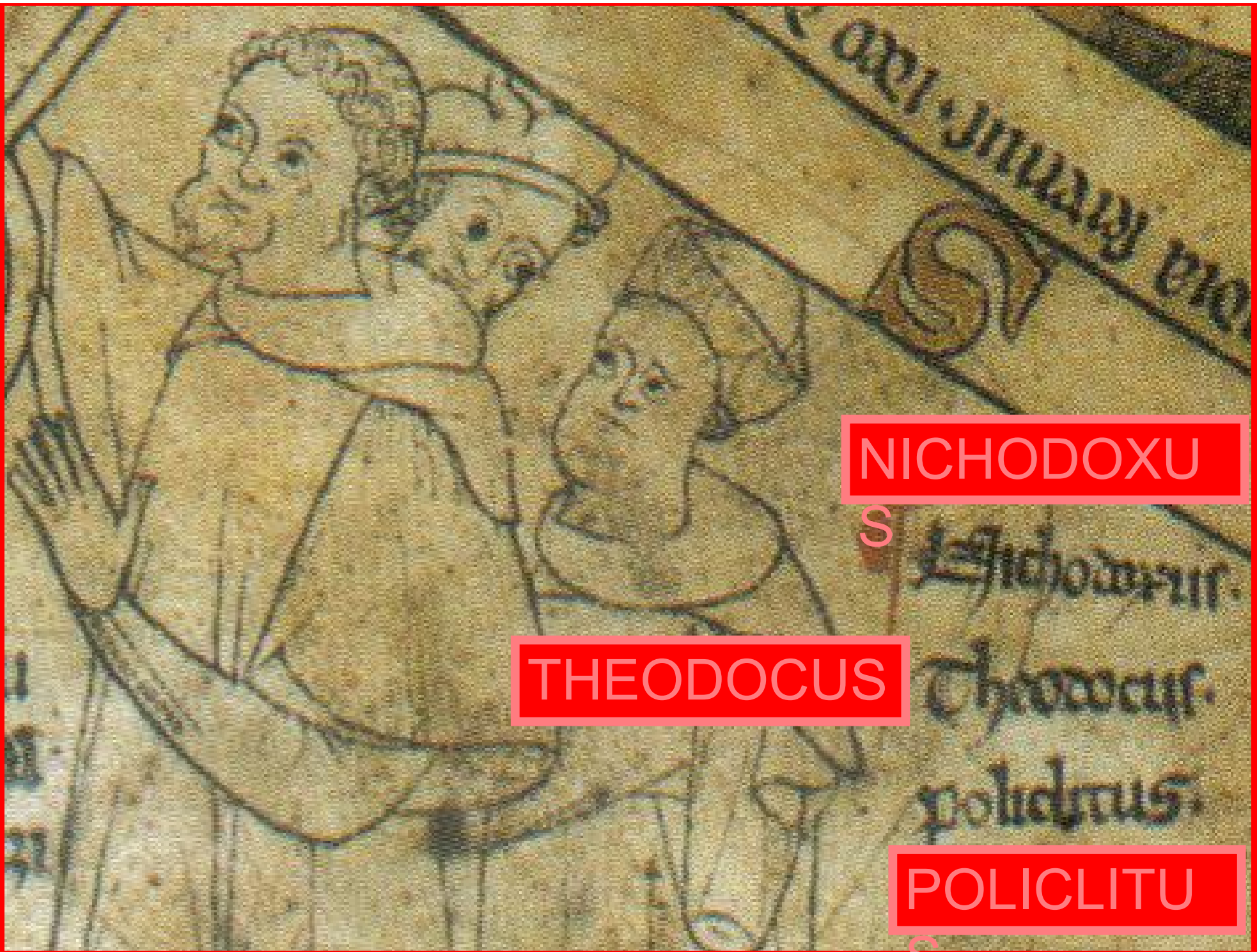

NICHODOXU

S

THEODOCUS

POLICLITU

Handwritten text in a medieval script, likely Latin, including the name 'Theodocus' and 'Policlitus'.

Jesus
Christ
Super St
Surveyor

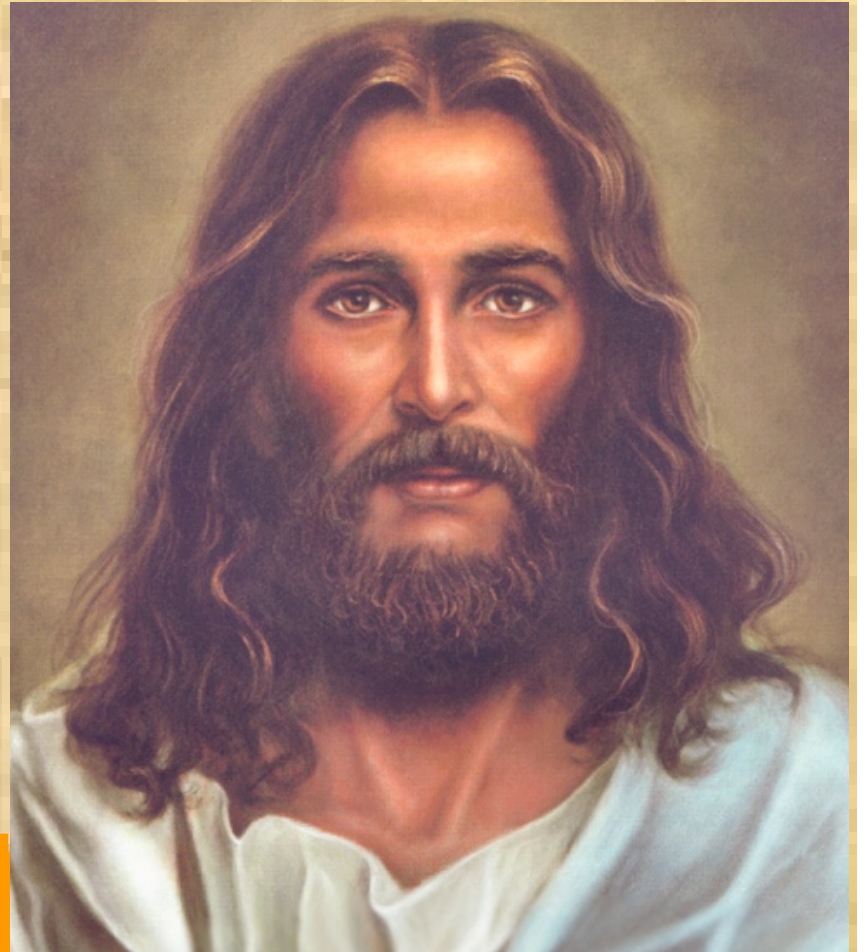

PROVERBS 8:27-

30

“When He prepared the heavens,
I was there when he set a compass
upon the face of the depth ...”



**GOD
MEASURES
THE WORLD
WITH A
COMPASS
IN A 13TH
CENTURY
ILLUMINATED
MANUSCRIPT**



HERO'S TREATISE: "ON THE DIOPTRA"

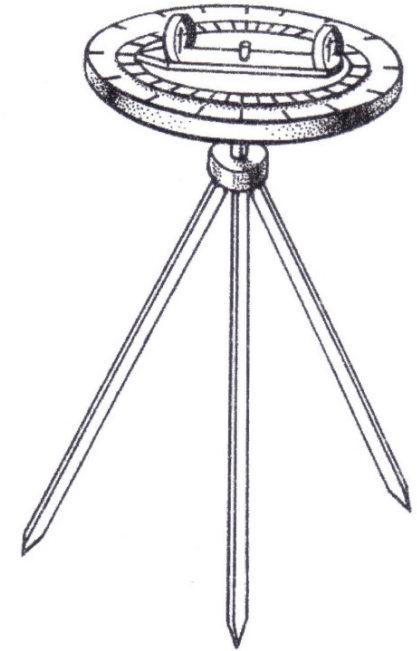

Dioptra.
Draft by Heron.

12. To find the perpendicular height of a visible point above the horizontal plane drawn through our position, without approaching the point.

A MANUAL FOR SOLVING THE PROBLEMS OF SURVEYING

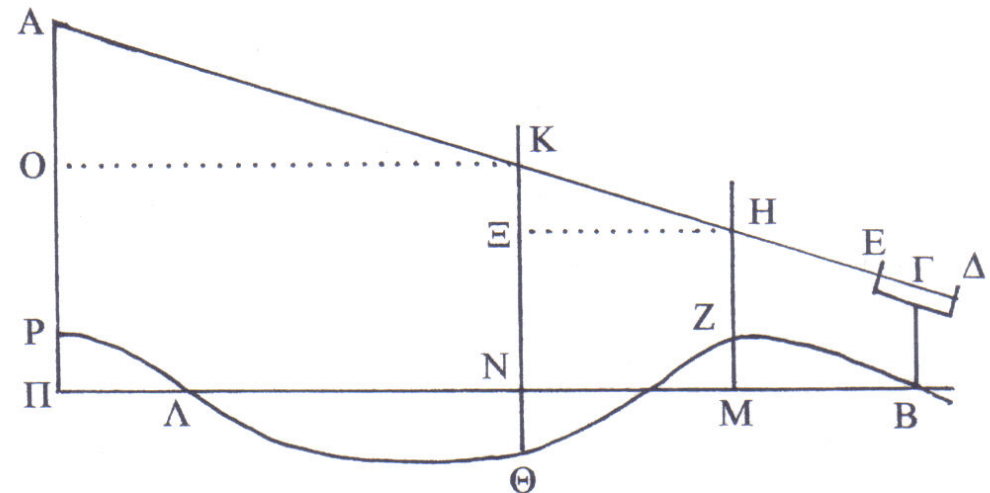

SOME OF HERO'S INVENTIONS

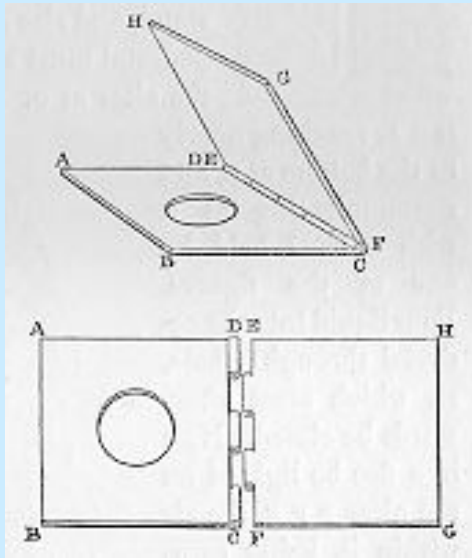

**VALVE
S**

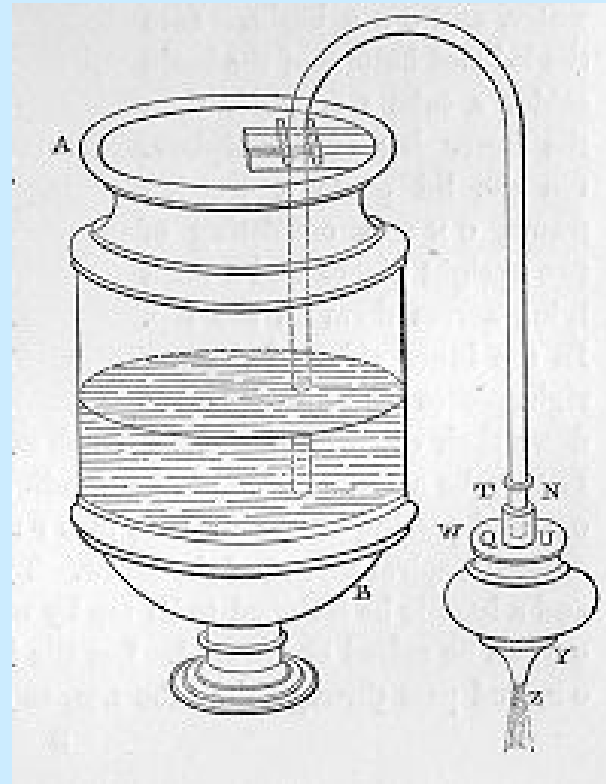

SIPHONS

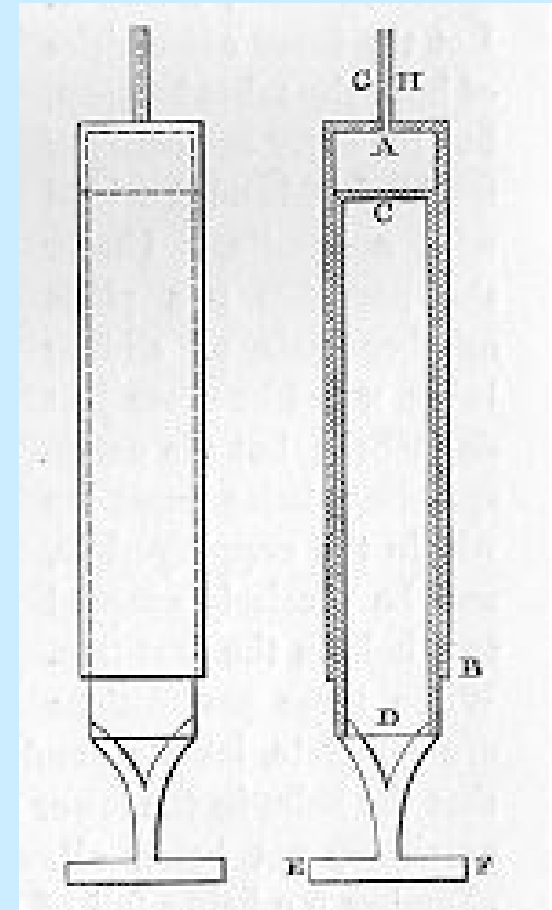

THE SYRINGE

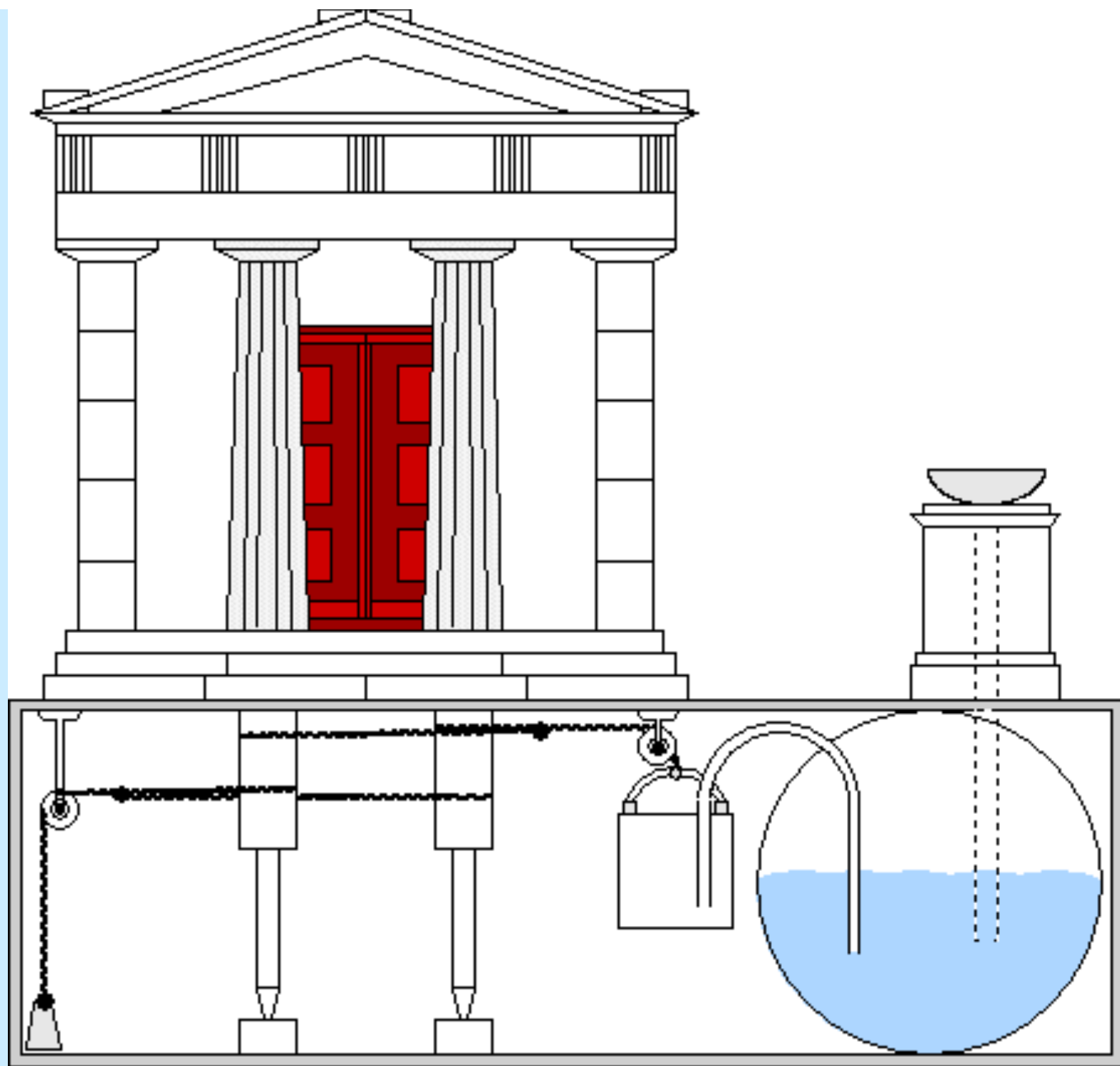

SURVEYOR PRESIDENTS OF THE USA



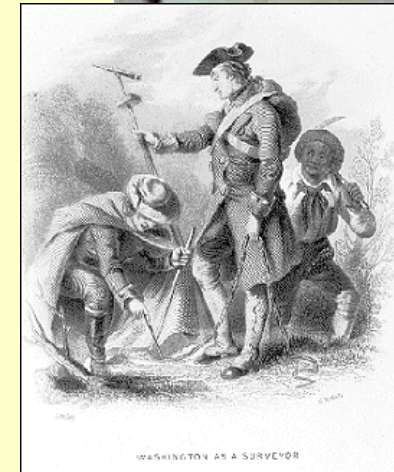
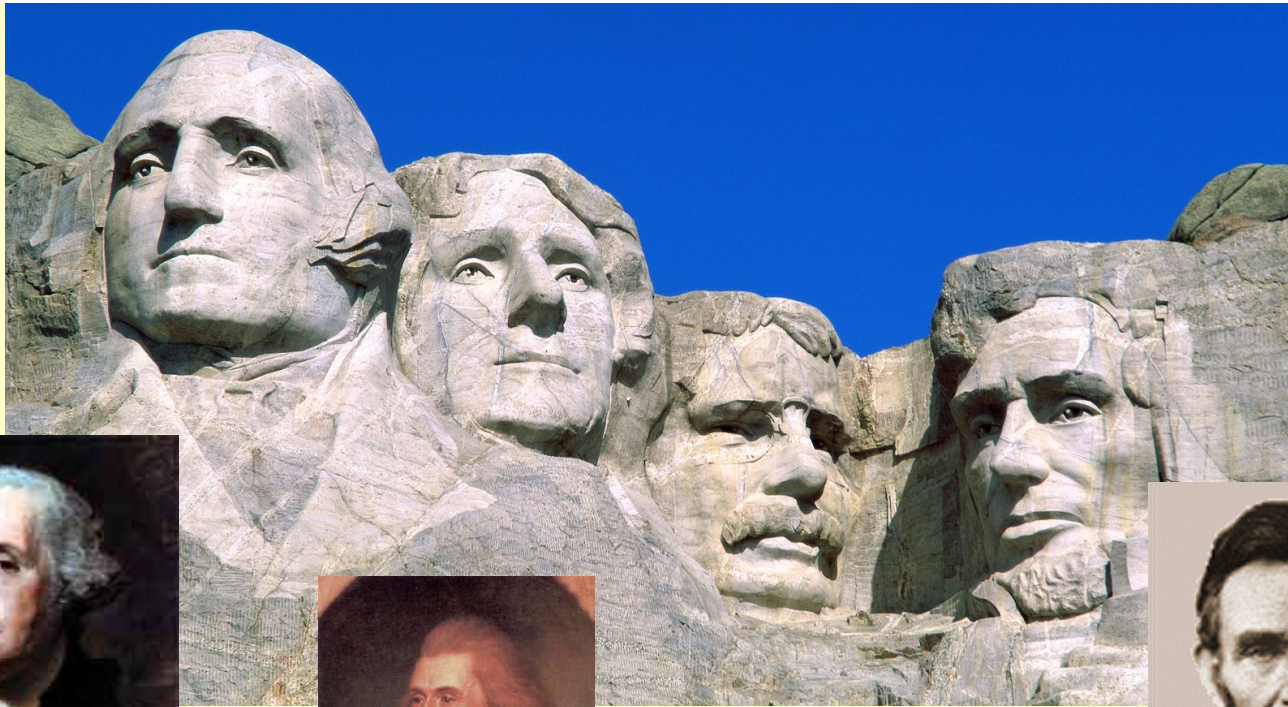

**GEORGE
WASHINGTON**



**THOMAS
JEFFERSON**

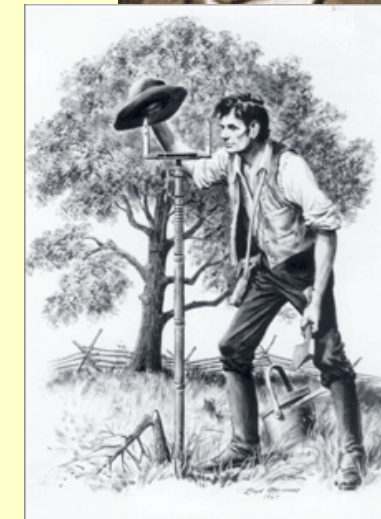

ABRAHAM LINCOLN

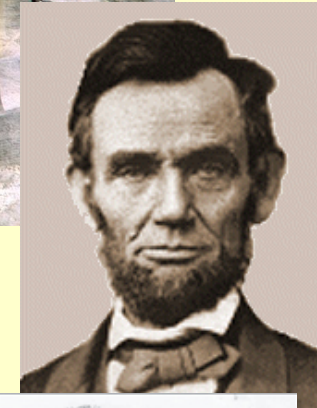



MOUNT BROCKMORE

GREAT SURVEYORS OF AUSTRALIA



JAMES
COOK

THOMAS
MITCHELL

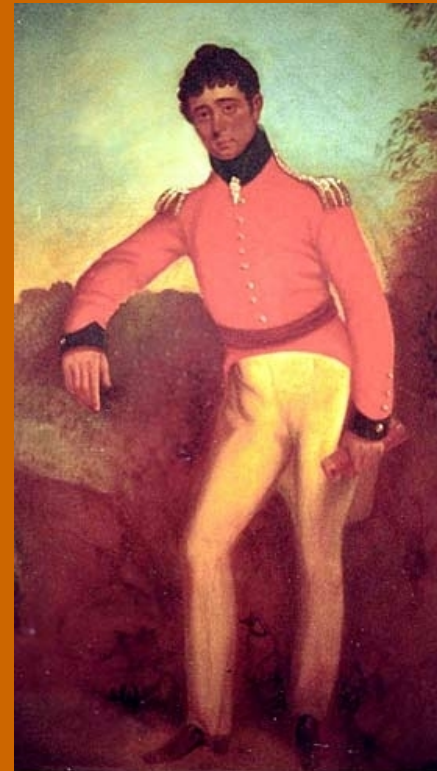

WILLIAM
LIGHT

JOHN
FORREST

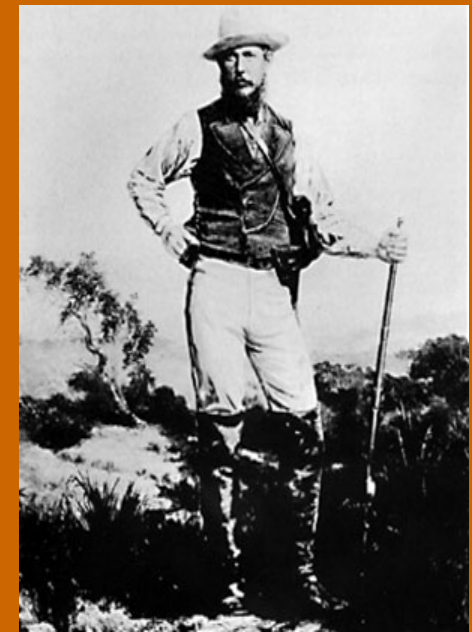

HERO SURVEYORS OF THE WORLD

DANIEL BOONE



Daniel Boone, the pioneer



COL. DANIEL BOONE

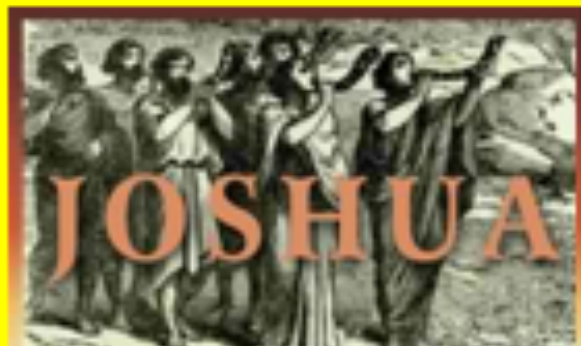

WYATT
EARP



Marion and Dixon Laying out
the Boundary Line



WHISTLER'S MOTHER



MOUNT EVEREST



SIR GEORGE EVEREST

CHARLES MASON AND JEREMIAH DIXON



WHISTLER'S FATHER



JOHN WHISTLER

GREAT AUSTRALIAN PROJECTS

CENTREPOINT TOWER



SYDNEY HARBOUR BRIDGE AND OPERA HOUSE

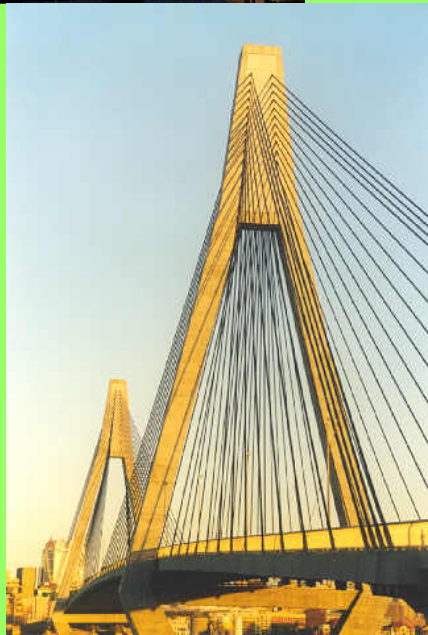

ANZAC BRIDGE

GREAT OVERSEAS PROJECTS BY AUSTRALIAN SURVEYORS



**PETRONAS
TOWERS
KUALA
LUMPUR**

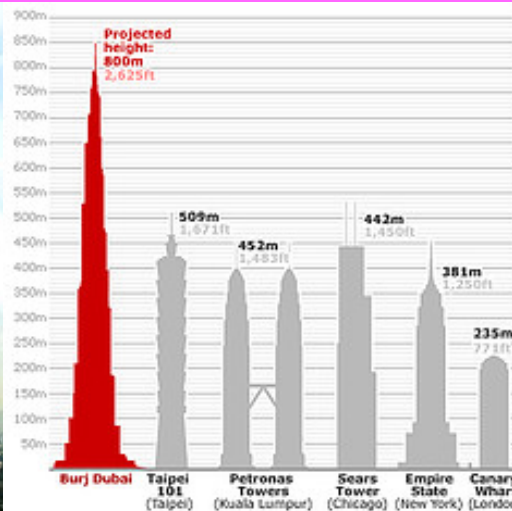

**BURJ
DUBAI**

**HONG
KONG
AIRPORT**



OVERSEAS ARCHAEOLOGICAL SURVEY EGYPT

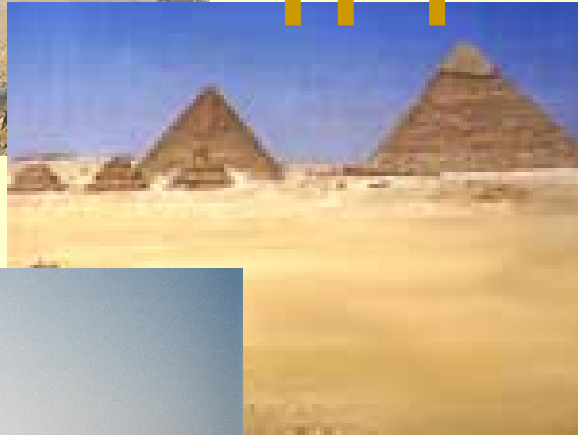

ANTARC TICA

UNSW SURVEYING GRADUATES



**JOHN BROCK WITH KEVIN DYNAN
DURING THE SYDNEY 2000 OLYMPIC
TRACK & THROWING ZONE SET OUT**

MARK TAYLOR





**TOM MIX – UNDISPUTED KING
OF THE SILENT MOVIE COWBOYS IN
“AFTER YOUR OWN HEART” (1921)**

RANDOLPH SCOTT IN CARSON CITY



MOVIE STAR SURVEYORS

JOURNEY TO THE CENTRE OF THE EARTH

JAMES MASON



THE FIGHTING KENTUCKIAN

JOHN WAYNE



BRAD PITT

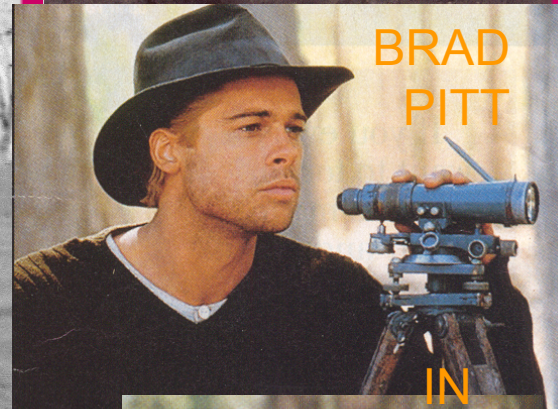

THE GHOST AND THE DARKNESS

VAL KILMER

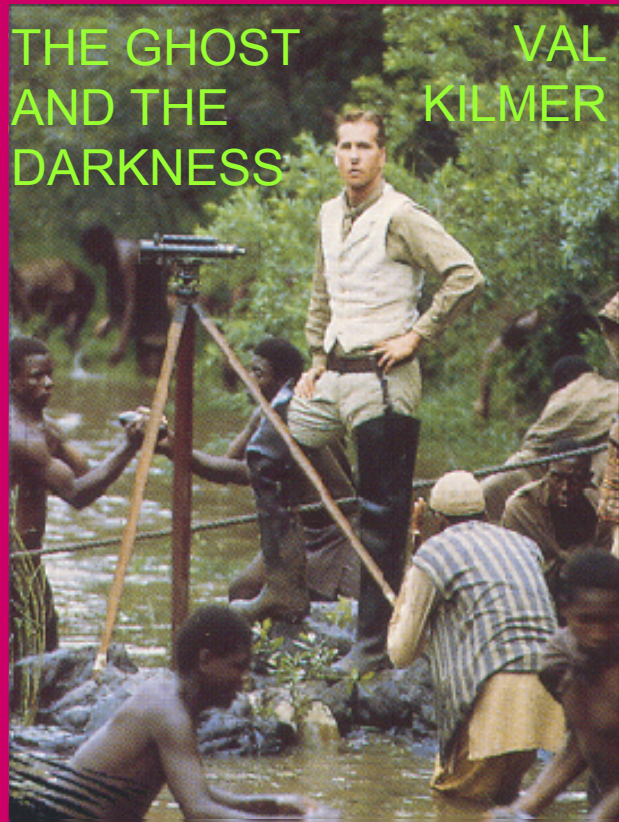

THE ENGLISHMAN THAT WENT UP A HILL BUT CAME DOWN A MOUNTAIN

HUGH GRANT



SEVEN YEARS IN TIBET

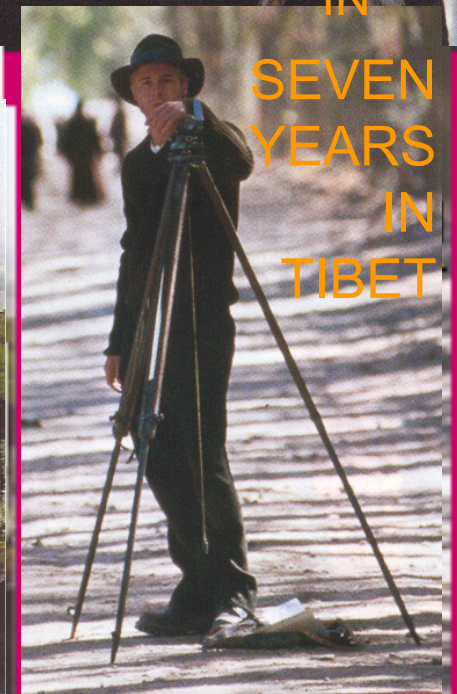

MOVIESTAR SURVEYORS

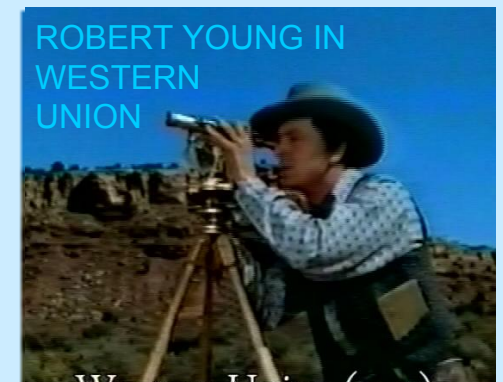

TV STAR SURVEYORS

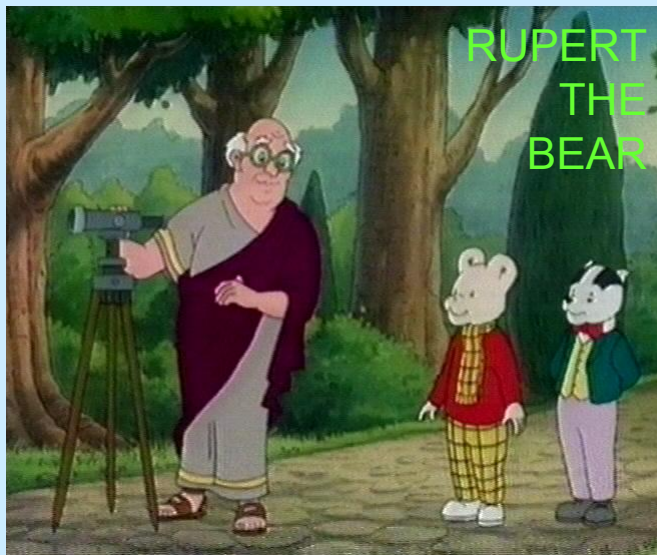

SURVEYING THE WORLD

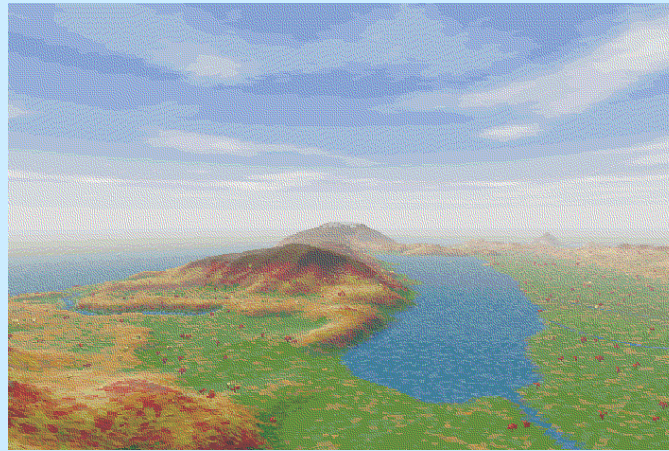

**IT'S ALL YOURS
YOUNG SURVEYORS !!!**

